

Clarion[®]

VDH9300

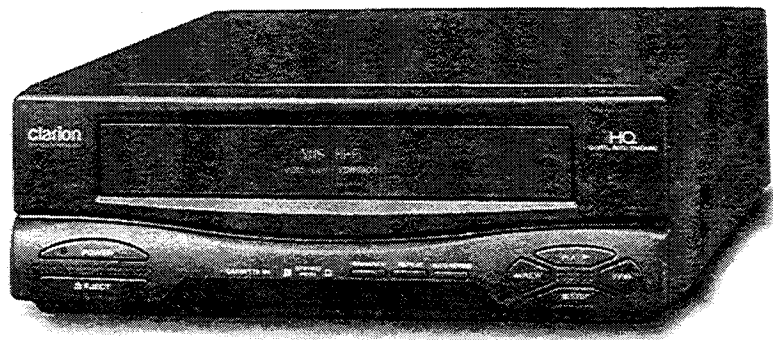



V I D E O C A S S E T T E
P L A Y E R

OWNER'S MANUAL

INSTALLATION GUIDE

Thank you for purchasing Clarion's VDH9300, developed to provide advanced features and functions for high quality performance. To obtain the best results and to avoid malfunction, please read the following instructions carefully before using.

WARNING: TO PREVENT FIRE OR ELECTRIC SHOCK, DO NOT EXPOSE THIS APPLIANCE TO RAIN OR MOISTURE.

	CAUTION RISK OF ELECTRIC SHOCKS DO NOT OPEN	
CAUTION: TO REDUCE THE RISK OF ELECTRIC SHOCK, DO NOT REMOVE COVER (OR BACK). NO USER-SERVICEABLE PARTS INSIDE. REFER SERVICING TO QUALIFIED SERVICE PERSONNEL.		



The lightning flash with arrowhead symbol, within an equilateral triangle, is intended to alert the user to the presence of uninsulated "dangerous voltage" within the product's enclosure that may be of sufficient magnitude to constitute a risk of electric shock to persons.



The exclamation point within an equilateral triangle is intended to alert the user to the presence of important operating and maintenance(servicing) instructions in the literature accompanying the appliance.

For your protection, please read these safety instructions completely before operating the appliance, and keep this manual for future reference.

Carefully observe all warnings, precautions, and instructions on the appliance, or the one described in the operating instructions and adhere to them.

IMPORTANT SAFEGUARDS

For your protection, please read these safety instructions completely before operating the appliance, and keep this manual for future reference.

Carefully observe all warnings, precautions, and instructions on the appliance, or the one described in the operating instructions and adhere to them.

USE

Power Sources- This set should be operated only from the type of power source indicated on the marking label. If you are not sure of the type of electrical power supplied at your home, consult your dealer or local power company. For those sets designed to operate from battery power, or other sources, refer to the operating instructions.



Water and Moisture- Do not use power-line operated sets near water-for example, near a bathtub, washbowl, kitchen sink, or laundry tub, in a wet basement, or near a swimming pool, etc.

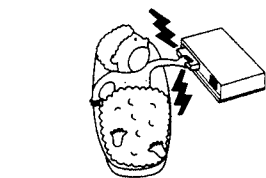

Accessories- Do not place the set on an unstable cart, stand, tripod, bracket, or table. The set may fall, causing serious injury to a child or an adult, and serious damage to the set. Use only a cart stand tripod, bracket, or table recommended by the manufacturer.

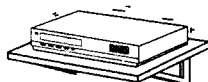

Object and Liquid Entry- Never push objects of any kinds into the set through openings as they may touch dangerous voltage points or short out parts that could result in a fire or electric shock. Never spill liquid of any kind on the set.

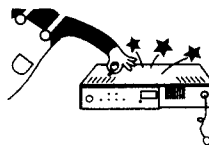

Ventilation- The slots and openings in the cabinet are provided for necessary ventilation. To ensure reliable operation of the set, and to protect it from overheating, these slots and openings must never be blocked or covered.

-Never cover the slots and openings with a cloth or other materials.

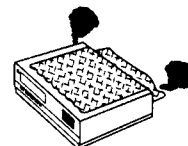

-Never block the slots and openings by placing the set on a bed, sofa, rug or other similar surface.

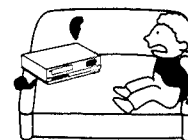

Attachments- Do not use attachments not recommended by the manufacturer, as they may cause hazards.

Cleaning- Unplug the set from the wall outlet before cleaning it. Do not use liquid cleaners or aerosol cleaners. Use a cloth light dampened with water for cleaning the exterior of the set.

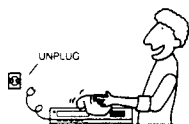

-Never place the set in a confined space such as a bookcase, or builtin cabinet, unless proper ventilation is provided.

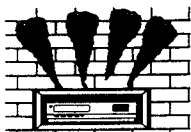

Portable Cart Warning- An appliance and cart combination should be moved with care. Quick stops, excessive force, and uneven surfaces may cause the appliance and cart combination to overturn.



- Do not place the unit near or over a radiator or heat register, or where it is exposed to direct sunlight.

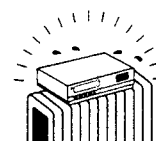

SERVICE

Damage Requiring Service-Unplug the set from the wall outlet and refer servicing to qualified service personnel under the following conditions:

-when the power cord or plug is damaged or frayed.

FRAYED OR TAUT
DC LINE



-If liquid has been spilled or objects have fallen into the set.

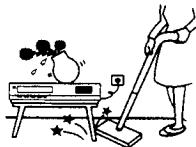

-If the set has been exposed to rain or water.

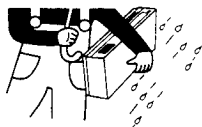

-If the set has been subject to excessive shock by being dropped, or the cabinet has been damaged.



-If the set does not operate normally when following the operating instructions. Adjust only those controls that are specified in the operating instructions. Improper adjustment of other controls may result in damage and will often require extensive work by a qualified technician to restore the set to normal operation.



-When the set exhibits a distinct change in performance this indicates a need for service.

Servicing- Do not attempt to service the set yourself as opening or removing covers may expose you to dangerous voltage or other hazards.

Refer all servicing to qualified service personnel.

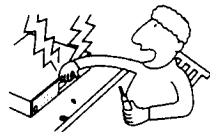

Replacement parts- When replacement parts are required, be sure the service technician has used replacement parts specified by the manufacturer that have the same characteristics as the original parts.

Unauthorized substitutions may result in fire, electric shock, or other hazards.

Safety Check- Upon completion of any service or repairs to the set, ask the service technician to perform routine safety checks (as specified by the manufacturer) to determine that the set is in safe operating condition.



Clarion VDH9300 VIDEOCASSETTE PLAYER

WARNING!

THE CLARION VDH9300 VIDEOCASSETTE PLAYER IS DESIGNED FOR REAR SEAT VIEWING OF VIDEOCASSETTES ONLY.

THIS PRODUCT IS NOT INTENDED FOR VIEWING BY THE DRIVER WHILE THE VEHICLE IS IN MOTION SINCE SUCH USE MAY DISTRACT THE DRIVER OR INTERFERE WITH THE DRIVER'S SAFE OPERATION OF THE VEHICLE AND MAY RESULT IN SERIOUS INJURY OR DEATH. SUCH USE MAY ALSO VIOLATE STATE LAW.

CLARION DISCLAIMS ANY LIABILITY FOR ANY BODILY INJURY, INCLUDING FATALITIES, OR PROPERTY DAMAGE THAT MAY RESULT FROM ANY IMPROPER OR UNINTENDED USES OF THIS PRODUCT.

ABOUT INSTALLATION

Installation of mobile audio and video components requires experience with a variety of mechanical and electrical procedures. Even though this manual provides general installation and operation instructions for your new Clarion VDH9300 Videocassette Player, it does not show the exact installation methods for your particular vehicle.

If you do not have the required knowledge and experience to successfully complete the installation, we strongly recommend consulting an authorized Clarion Pro Audio dealer about professional installation options.

TABLE OF CONTENTS

Introduction.....	3
Precautions And Videocassette Use.....	4
Installation And Wiring.....	6
Description Of Controls And Indicators.....	8
Description Of Connectors.....	10
Description Of Remote Control	11
Operating The VDH9300	13
Dew Sensor Operation	18
Head Cleaning.....	18
Troubleshooting	19
Specifications	20
FCC Statement	20

INTRODUCTION

The Clarion VDH9300 is a full-featured VHS videocassette player specifically created for the mobile environment. It is designed to work through the Clarion TTX7101 TV Tuner and VMA9181 Video Monitor and for a complete video solution for your vehicle. The VDH9300 includes the following features:

- 4-head VHS Hi-Fi stereo system for high-quality playback of NTSC video and near CD-quality audio tracks
- Microprocessor-based, full electronic-logic control system with feather-light push-button operation
- Motorized front-loading system for fast videocassette loading and removal
- Built-in 12 Vdc operation only – eliminates need to convert power supply for mobile use
- Rear-mounted RCA outputs for standard connections to your mobile system
- Infrared remote control for convenient wireless operation
- 2-speed playback of SP and EP videocassettes

- Diamond Like Carbon(DLC) coated tape head drum for extended head durability and lessened tape wear
- 2-step forward/reverse picture search for quick location of a desired video segment at 3- or 7-times SP speed
- Auto rewind and auto repeat functions
- Enhanced mode to stabilize picture roll and color enhancement on rental videocassettes
- Dew sensor to warn of condensation

About The Manual And Warranty

To start enjoying your new Clarion VDH9300, please read the remaining instructions listed in this manual. (If the unit was installed by your Clarion Pro Audio dealer, then start with page 8). Keep all instructions for future reference.

This product is covered by a limited warranty (see the enclosed warranty card). Save the sales receipt to protect your purchase and aid in warranty service.

PRECAUTIONS AND VIDEOCASSETTE USE

Installation Precautions

- This unit operates on an automotive 12-volt negative ground power source and requires additional mobile audio and video components for proper operation.
- Before installation, disconnect the (-) negative lead from the vehicle's battery.
- Use only supplied screws and hardware. Make sure all connections and components are fastened securely.
- At the proposed installation site, make sure there is adequate space to accommodate the unit's dimensions (and mounting brackets) and provide adequate ventilation (see *Installation* on page 6).
- Use extreme caution when drilling around electrical wiring, brake lines, and fuel lines. Check clearances on both sides of a planned installation surface before drilling any holes or installing any screws. Always wear protective eyewear when using power tools.

- Use only high-quality RCA cables that are no longer than necessary for direct connections to other components in the system. Extra-length audio and video cables can cause signal loss and act as an "antenna" for noise.
- When routing RCA cables, keep them away from power cables and output speaker wires.
- If a fuse needs replacement, use the same value as the original. Do not substitute another rating.

Operation Precautions

- Do not allow liquids or foreign objects to enter the unit or remote control.
- If the unit or remote control should become wet, turn off all power and let your authorized Clarion Pro Audio dealer clean or service the equipment.

DO NOT ATTEMPT TO OPEN OR SERVICE THE UNIT OR REMOTE CONTROL. THE INTERNAL PARTS ARE NOT USER-SERVICEABLE. DOING SO WILL VOID THE WARRANTY.

- Do not force a videocassette upside down into the unit.
- Do not place heavy objects on the unit or remote control.
- Do not drop or excessively jar the unit or remote control.
- Do not use liquid cleaners on any surfaces. Only use a soft (cotton or other non-static) cloth to wipe off fingerprints or other imprints from the faceplate or remote control.
- Do not subject the unit to direct sunlight or an extremely hot environment (e.g., closed windows on a hot summer day, direct path of heater vent, etc.).
- Avoid using the unit under the following conditions:
 - After extended parking on an extremely hot or cold day
 - Near strong magnetic fields
 - In an environment with excessive humidity, dust, or vibration (e.g., off-road travel, etc.)
- If the unit has accumulated moisture condensation (e.g., after parking the vehicle outside overnight), allow the unit to automatically remove it through a built-in Dew Sensor circuit before attempting to play a videocassette. See *Dew Sensor Operation* on page 18.

Videocassette Use

- Use only VHS-tape(T-30, T-60, T-120, T-160, or T-180) videocassettes.
- Do not repeatedly load or unload a videocassette without interim playback; doing so may cause the tape to slack and become damaged.
- Do not directly touch the magnetic tape surface.
- Do not disassemble a videocassette.
- Avoid exposing a videocassette to direct sunlight and keep it away from heat sources (e.g., heater vent).
- Avoid extreme environments such as high humidity, excessive vibrations or jarring, strong magnetic fields (e.g., speaker magnet, etc.) and dust.
- Always place a videocassette back in its case after use.

FCC Warning

Any unauthorized changes or modifications to this equipment would void the user's authority to operate.

Clarion VDH9300 VIDEOCASSETTE PLAYER

INSTALLATION AND WIRING

Installing The VDH9300

The VDH9300 can be mounted horizontally or vertically, as shown in Figures 1 and 2.

NOTE: For best results, Clarion recommends horizontal mounting, since vertical mounting will produce increased picture jitter while the vehicle is moving.

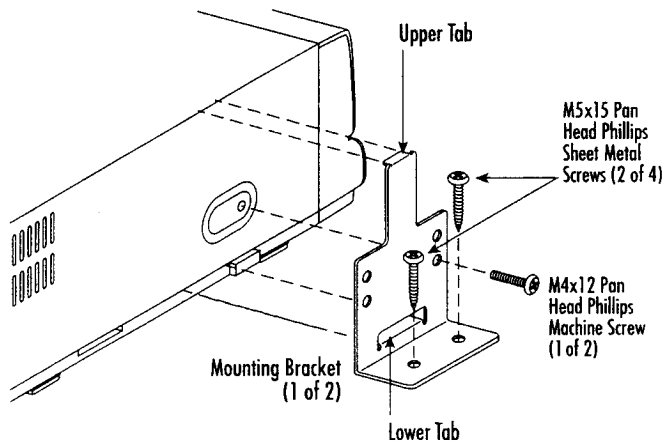

Figure 1. Horizontal mounting of VDH9300.

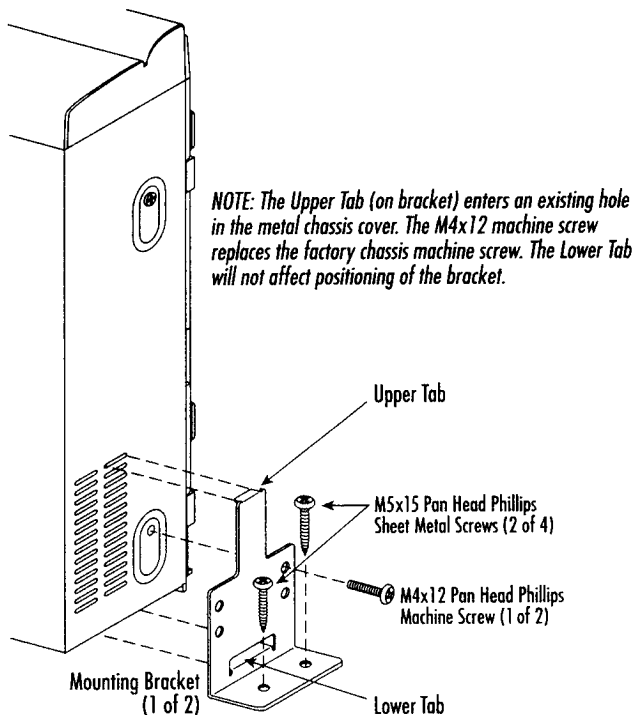

Figure 2. Vertical mounting of VDH9300.

Wiring The VDH9300 Videocassette Player

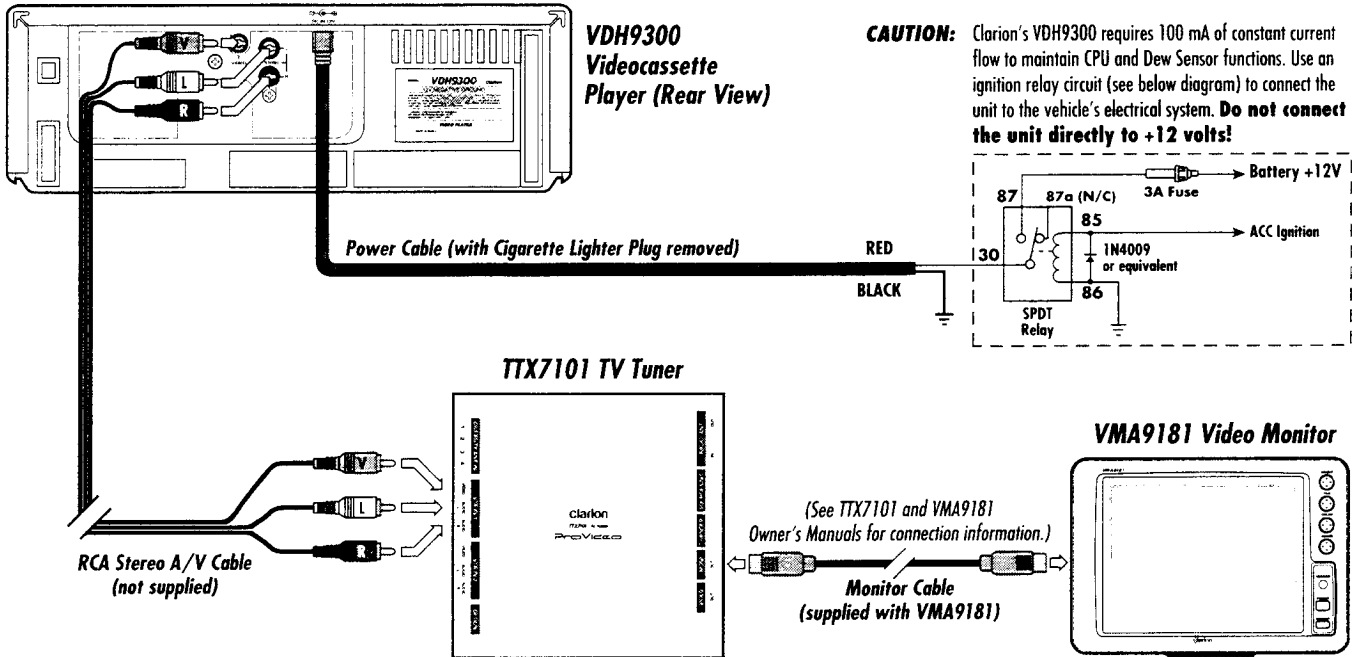

Figure 3. Wiring diagram for VDH9300.

Clarion VDH9300 VIDEOCASSETTE PLAYER

DESCRIPTION OF CONTROLS AND INDICATORS

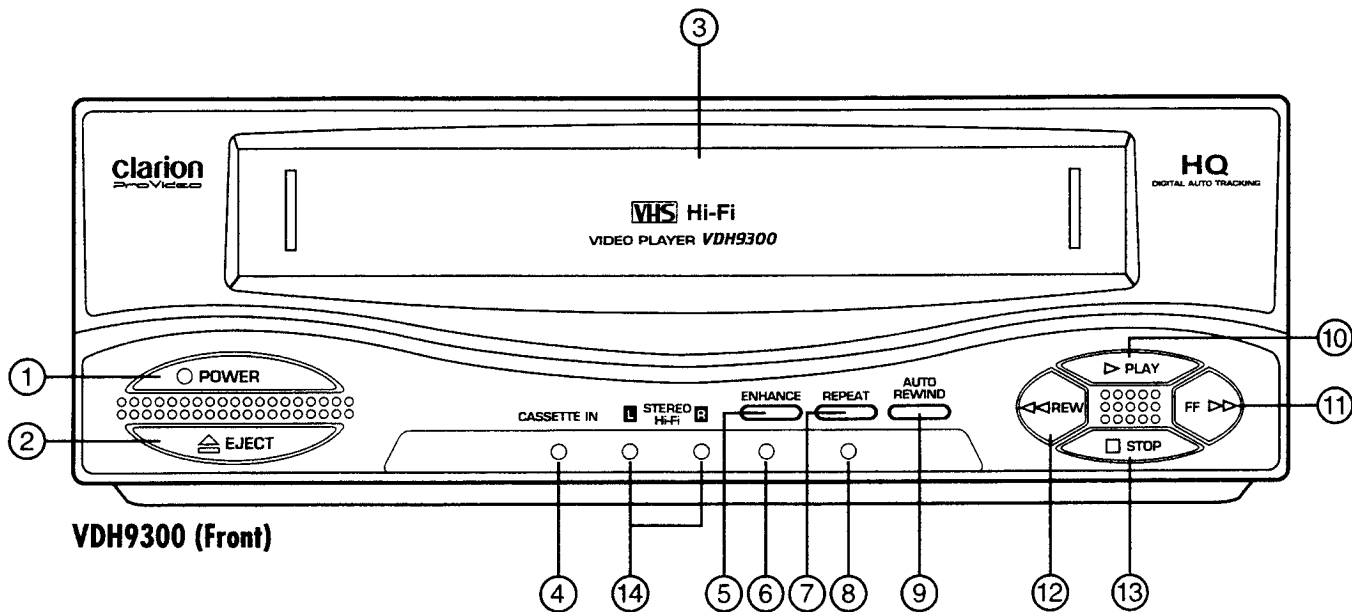

Figure 4. The VDH9300's controls and indicators (see descriptions on the next page).

- ① **POWER Button**
Press to power the unit ON or OFF.
- ② **EJECT Button**
Press to eject a videocassette from the compartment.
- ③ **CASSETTE Compartment**
Insert a videocassette which automatically loads the tape.
- ④ **CASSETTE Indicator**
Illuminates when a videocassette is inserted.
- ⑤ **ENHANCE Button**
Press once to reduce picture noise (e.g., when viewing older rented tapes). Press again to cancel this mode.
- ⑥ **ENHANCE Indicator**
Illuminates when ENHANCE mode is ON. Flashes when the Dew sensor is activated.
- ⑦ **REPEAT Button**
Press once to play a videocassette repeatedly; when the tape reaches the end, it will automatically rewind and start play again. Press again to cancel this mode.
- ⑧ **REPEAT Indicator**
Illuminates when REPEAT mode is ON.
- ⑨ **AUTO REWIND Button (A-REWIND on Remote Control)**
Press to rewind the tape to the beginning and start play.
- ⑩ **PLAY Button**
Press button to play the videocassette.
- ⑪ **FF Button**
Press FF to fast forward the tape. If PLAY is engaged, press FF to forward search for a desired video segment.
- ⑫ **REW Button**
Press REW to rewind the tape. If PLAY is engaged, press REW to reverse search for a desired video segment.
- ⑬ **STOP Button**
Press to stop any play, fast forward, or rewind mode.
- ⑭ **STEREO OUTPUT Indicators**
When a Hi-Fi stereo videocassette is being played, the "L" and "R" indicators will illuminate. Use the Remote Control to select Stereo, Left, Right, or Mono (see page 12). Unlit indicators signify the tape has a mono soundtrack.

Clarion VDH9300 VIDEOCASSETTE PLAYER

DESCRIPTION OF CONNECTORS

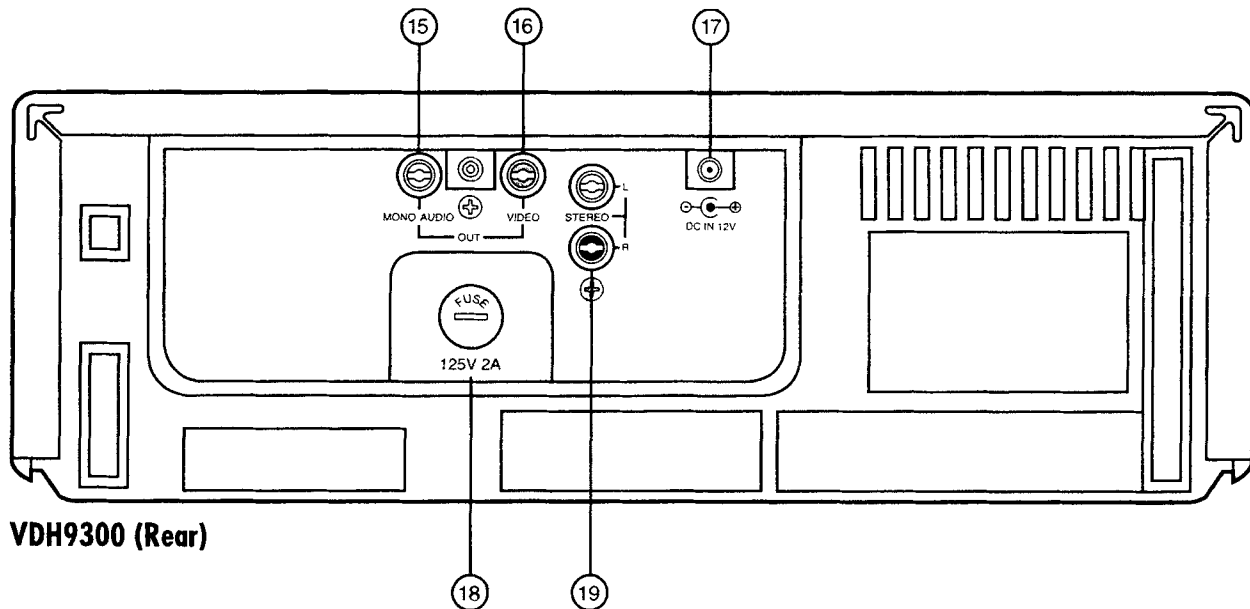

Figure 5. The VDH9300's connectors (see descriptions on the next page).

- 15 MONO AUDIO OUT (RCA Jack)
Use an RCA audio cable (not supplied) to connect mono audio from the VDH9300 to a mono audio input.
- 16 VIDEO OUT (RCA Jack)
Use an RCA video cable (not supplied) to connect video from the VDH9300 to the TTX7101 Video Tuner.
- 17 DC IN 12V (Mini Jack)
Use the supplied dc power cord (with cigarette lighter end) to connect the VDH9300 to the vehicle's 12-volt electrical system.
- 18 FUSE
Built-in fuse holder contains a 125-volt (2-ampere) fuse to protect internal VDH9300 circuits.
- 19 STEREO L/R (RCA Jacks)
Use a stereo RCA audio cable (not supplied) to connect stereo audio from the VDH9300 to the TTX7101 Video Tuner.

DESCRIPTION OF REMOTE CONTROL

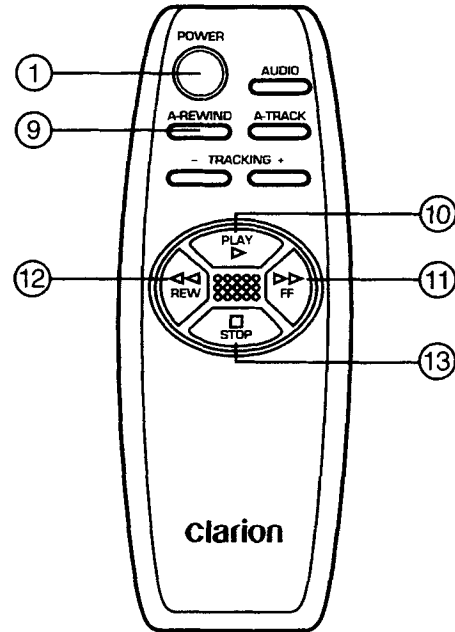
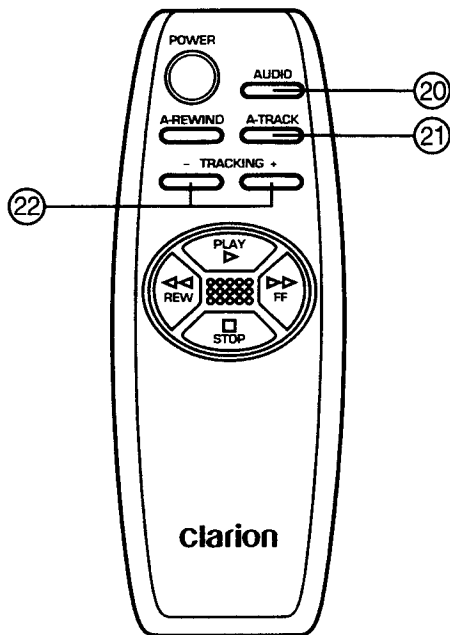

Figure 6. Common functions on the VDH9300's Remote Control (see page 9 for descriptions).

Clarion VDH9300 VIDEOCASSETTE PLAYER

DESCRIPTION OF REMOTE CONTROL (CONT'D)



④ AUDIO Button

When playing a videocassette with a stereo Hi-Fi sound-track, press AUDIO one or more times to change the audio mode in the following repeating order: Stereo → Left → Right → Mono → Stereo....etc.

④ A-TRACK Button

Press to reapply automatic tracking to videocassette. *(NOTE: The VDH9300 automatically sets tracking for best picture each time a videocassette is inserted into the unit. For older videocassettes, use this feature at different positions in the tape to adjust tracking due to worn tape).*

④ TRACKING +/- Buttons

Press + (or -) to increase (or decrease) manual tracking to reduce picture tracking noise. *(NOTE: Use this function if automatic tracking does not produce the desired result).*

Figure 7. Unique functions on the VDH9300's Remote Control.

Inserting Batteries Into The Remote Control

1. Locate the battery compartment on the back of the Remote Control.
2. Slide open the door and insert two AAA batteries (supplied), matching polarity as shown inside the compartment.
3. Slide the door closed until it locks.

Using The Remote Control

Inside the vehicle, simply aim the Remote Control directly at the VDH9300's faceplate and press any desired button. For best results, also note the following:

- Aim the Remote Control from no further than 7 feet away and no more than 3 feet on either side of the VDH9300 faceplate.
- Direct sunlight or very bright light will reduce sensitivity to remote signal commands.
- Objects between the VDH9300 and its Remote Control will interfere or block remote signal commands.

OPERATING THE VDH9300

Loading And Playing A Videocassette

1. Gently insert a videocassette (with the labeled side up) into the CASSETTE compartment, as shown in Figure 8. The unit will automatically power on, load the tape, and the CASSETTE IN indicator will illuminate.
2. Press the PLAY button to start playing the tape.

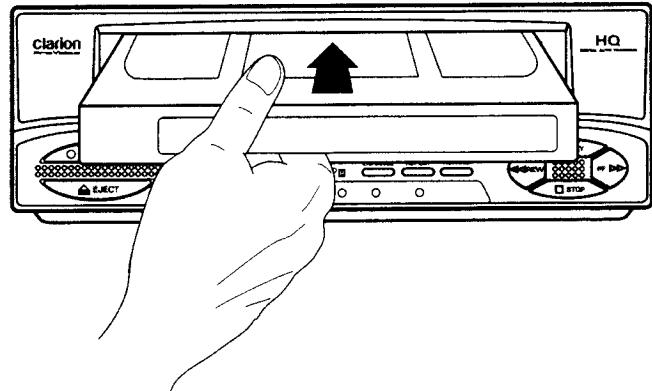

Figure 8. Loading a videocassette into the VDH9300.

Clarion VDH9300 VIDEOCASSETTE PLAYER

Ejecting A Videocassette

1. Press EJECT.
2. The tape will automatically unload, the CASSETTE IN indicator will turn off, and the videocassette will be ejected, as shown in Figure 9.

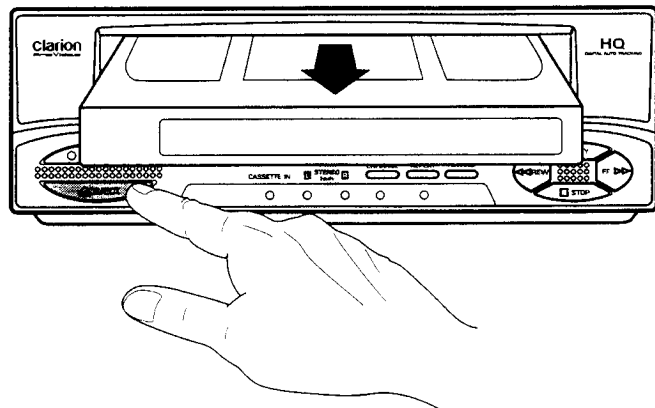

Figure 9. Ejecting a videocassette from the VDH9300.

Stopping And Playing A Videocassette

- To stop play, press STOP (see Figure 10).
- To resume play, press PLAY (see Figure 10).

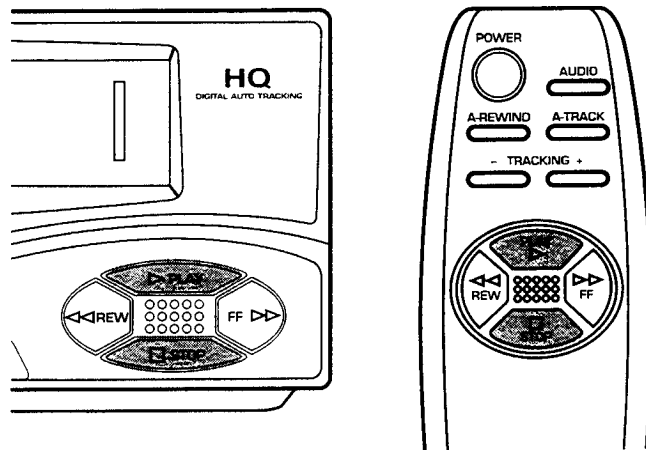

Figure 10. PLAY and STOP on the VDH9300 and Remote Control.

Using Rewind And Fast Forward

- To rewind the tape, first press STOP and then press REW (see Figure 11).
- To fast forward the tape, first press STOP and then press FF (see Figure 11).

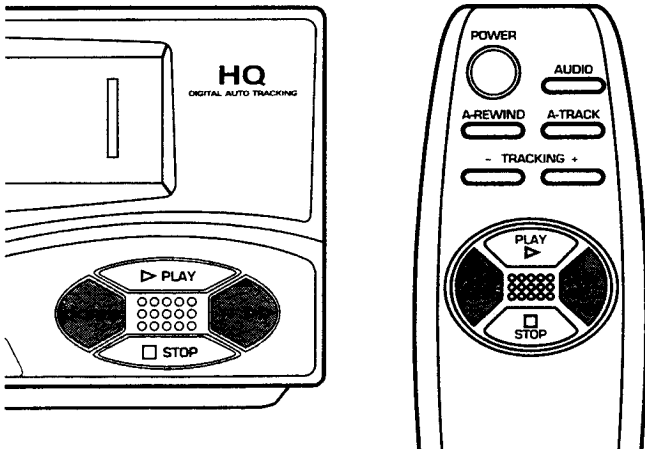

Figure 10. REW and FF on the VDH9300 and Remote Control.

Using Forward And Reverse Search

The VDH9300 includes a 2-step forward/reverse picture search for quick location of a desired video segment at 3- or 7-times SP speed.

- To forward search the tape, press FF once (for 3-times SP speed) or twice (for 7-times SP speed) while the tape is playing (see Figure 11). When you find the desired video segment, press PLAY to cancel this function and resume playing the tape.
- To reverse search the tape, press REW once (for 3-times SP speed) or twice (for 7-times SP speed) while the tape is playing (see Figure 11). When you find the desired video segment, press PLAY to cancel this function and resume playing the tape.

NOTE: The tape must be playing first for these functions to occur.

Clarion VDH9300 VIDEOCASSETTE PLAYER

Using Repeat

- Press REPEAT once to play a videocassette repeatedly (see Figure 12). The REPEAT indicator will illuminate and all other buttons will become inoperable. At end of tape, the unit will rewind the tape to beginning and begin play again. This sequence will occur indefinitely until it is cancelled.
- To cancel repeat, press REPEAT again. The REPEAT indicator will turn off and all buttons will become operable.

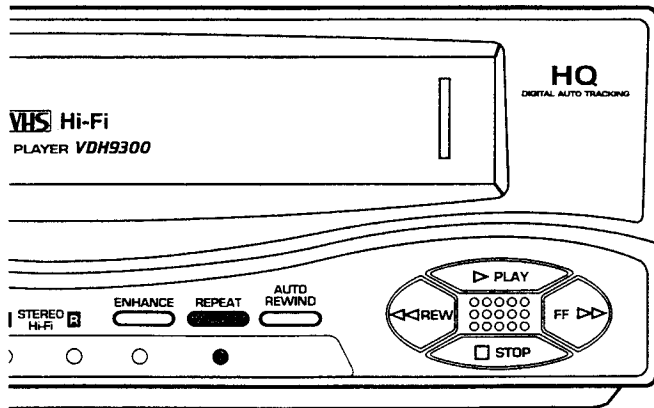

Figure 12. REPEAT on the VDH9300.

Using Auto Rewind

Auto Rewind is a great feature when you're unsure of a tape's position in the videocassette. You can use it to automatically rewind a videocassette to the top and then start play.

Simply press AUTO REWIND or A-REWIND on the Remote Control (see Figure 13).

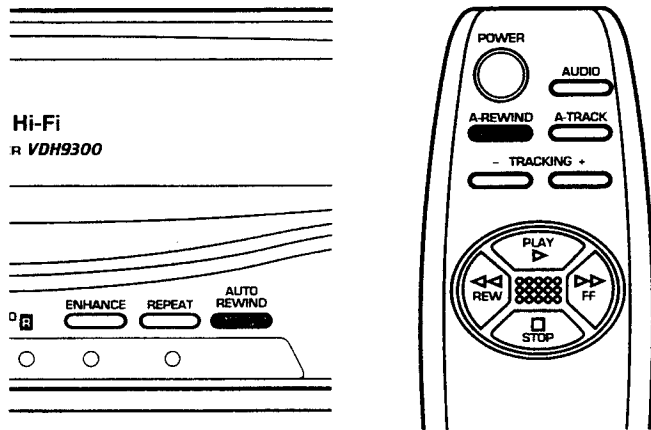

Figure 13. AUTO REWIND on the VDH9300 and Remote Control.

Using Auto And Manual Tracking

Using the Remote Control, you can adjust the picture tracking automatically or manually (see Figure 14).

- Automatic tracking is initiated when you first insert a videocassette in the CASSETTE Compartment. To apply automatic tracking to later portions of the same tape, press **AUTO TRACK** (or **A-TRACK** on the remote control) as often as desired.
- Manual tracking may be used when auto tracking does not fully correct picture tracking noise. Press **TRACKING +** (or **-**) to increase (or decrease) manual tracking.

NOTE: If you reach the limit on either TRACKING + or - and notice no further improvement, the tape may be severely worn or the unit's heads may need cleaning (also see Troubleshooting on page 19).

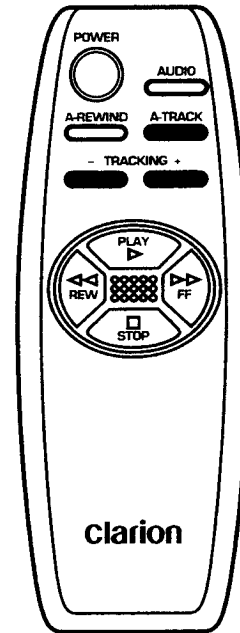

Figure 14. Auto and Manual Tracking functions are located on the Remote Control.

Clarion VDH9300 VIDEOCASSETTE PLAYER

Changing Audio Modes

Using the Remote Control, you can select different audio modes when playing a VHS Hi-Fi stereo videocassette (see Figure 15).

- Press AUDIO one or more times to change the audio mode in the following repeating order:

Stereo → Left → Right → Mono → Stereo...etc.

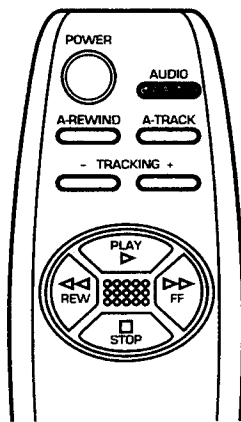

Figure 15. Audio modes are changed using the Remote Control.

DEW SENSOR OPERATION

The VDH9300 is equipped with a built-in Dew Sensor circuit that automatically detects moisture condensation. When activated, the Dew Sensor circuit will inhibit the drive section to avoid damaging heads due to sticking tape. The unit will be powered on, but it will not accept a videocassette. The Enhance Indicator will flash to notify you of this condition.

NOTE: If a videocassette was left in the VDH9300, press EJECT to avoid damaging the tape during this procedure.

Leave the power on so the unit can warm up and dry any accumulated moisture. When the Enhance Indicator stops flashing, the unit will return to full operation.

HEAD CLEANING

Over time the picture may become blurred, interrupted, or noisy. Probably dirt has accumulated on the video heads and the unit will require cleaning. You can verify this symptom by playing several different videocassettes. If the problem is the same, then the heads need to be cleaned. Please consult your nearest Clarion Pro Audio dealer for recommendations on cleaning products and service.

TROUBLESHOOTING

Symptom	Cause	Solution
Unit does not work.	No power.	Verify power wiring to unit (see page 7).
	Fuse is blown.	Replace fuse with same value (see pages 10 and 11).
Pressing buttons has no effect.	Unit is in Repeat mode and buttons are inoperable (see page 16).	Press REPEAT to cancel mode and return buttons to full operation.
Pressing POWER will not turn unit off.	Unit is in Repeat mode and buttons are inoperable (see page 16).	Press REPEAT to cancel mode and return buttons to full operation.
Tape will not rewind or fast forward.	Tape is fully rewound or at beginning.	Eject videocassette and check tape position.

Symptom	Cause	Solution
Picture is noisy during playback.	Tracking is not set optimally.	Perform tracking adjustment (see page 17).
	Videocassette is worn.	Eject videocassette and play another.
	Video heads are dirty.	Clean unit – see your Clarion dealer.
Videocassette does not insert into unit.	Another tape is already in unit.	Eject first videocassette and insert a second tape.
	Dew Sensor is on.	Leave power on for 2 hrs. (see page 18).
Hi-Fi indicators do not illuminate.	Videocassette only has a mono soundtrack.	Play a videocassette that has a Hi-Fi stereo soundtrack.
	Unit is set to mono.	Use AUDIO button to change modes (see page 18).

Clarion VDH9300 VIDEOCASSETTE PLAYER

SPECIFICATIONS

General Specifications

Power Requirement:	12 volts dc
Power Consumption:	12 watts, Power On 1.2 watts, Power Off
Weight:	7.5 lb (3.4 kg)
Dimensions (<i>w x h x d</i>):	10.4 x 3.5 x 11.4 in. (265 x 89 x 290 mm)
Supplied Accessories:	Remote Control, (2) AAA Batteries, and Power Cable (with Cigarette Lighter Plug)

Tape Deck Specifications

Format:	VHS Standard
Scanning System:	NTSC
Tape Width:	0.498 in. (12.65 mm)
Tape Speed:	SP = 1.313 in./s (33.36 mm/s) EP = 0.657 in./s (16.68 mm/s)

Playing Time:	6 hours with T-120 on EP speed
Video Output:	1.0 V _{p-p} , 75 ohms, unbalanced
Picture Resolution:	Up to 230 horizontal lines
Audio Output Level:	-5 dBm, 10 kohms, unbalanced

FCC STATEMENT

This equipment has been tested and found to comply with the limits for a Class B digital device, pursuant to Part 16 of the FCC Rules. These limits are designed to provide reasonable protection against harmful interference in a residential installation. This equipment generates, uses, and can radiate radio frequency energy and, if not installed and used in accordance with the instructions, may cause harmful interference to radio communications. However, there is no guarantee that interference will not occur in a particular installation.

If this equipment does cause harmful interference to radio or television reception, which can be verified by turning the unit off and on, the user is encouraged to consult the dealer or an experienced radio/television technician for help.